

Description

The DULXX11D3L is a uni-directional TVS diode, utilizing leading monolithic silicon technology to provide fast response time and low ESD clamping voltage, making this device an ideal solution for protecting voltage sensitive high-speed data lines. The DULXX11D3L has an ultra-low capacitance, and complies with the IEC 61000-4-2 (ESD) standard with $\pm 25\text{kV}$ air and $\pm 20\text{kV}$ contact discharge. It is assembled into a SOD-323 lead-free package. The small size, ultra-low capacitance and high ESD surge protection make DULXX11D3L an ideal choice to protect cell phone, digital video interfaces and other high speed ports.

Mechanical Characteristics

- ◆ Package: SOD-323
- ◆ Lead Finish: Matte Tin
- ◆ Case Material: "Green" Molding Compound.
- ◆ UL Flammability Classification Rating 94V-0
- ◆ Moisture Sensitivity: Level 3 per J-STD-020
- ◆ Terminal Connections: See Diagram Below
- ◆ Marking Information: See Below

Dimensions and Pin Configuration

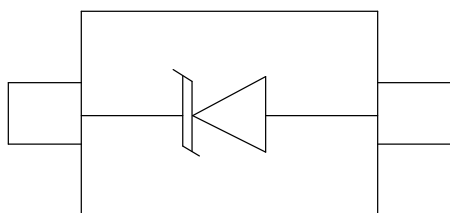

Circuit and Pin Schematic

Features

- ◆ Ultra low leakage: nA level
- ◆ Ultra low Operating voltage: 3.3V,5V
- ◆ Low clamping voltage
- ◆ Complies with following standards:
 - IEC 61000-4-2 (ESD) immunity test
 - Air discharge: $\pm 25\text{kV}$
 - Contact discharge: $\pm 20\text{kV}$
 - IEC61000-4-4 (EFT) 40A (5/50ns)
 - IEC61000-4-5 (Lightning) 5A (8/20 μs)
- ◆ RoHS Compliant

Applications

- ◆ Cellular Handsets and Accessories
- ◆ Display Ports
- ◆ MDDI Ports
- ◆ USB Ports
- ◆ Digital Video Interface(DVI)
- ◆ PCI Express and Serial SATA Ports

Marking Information

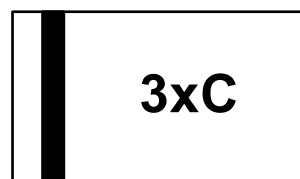

3xC:Device Marking Code

Ordering Information

Part Number	Marking	Packaging	Reel Size
DULXX11D3L	3xC	3000/Tape & Reel	7 inch

Absolute Maximum Ratings ($T_A=25^\circ\text{C}$ unless otherwise specified)

Parameter	Symbol	Value	Unit
ESD per IEC 61000-4-2 (Air)	V _{ESD}	±25	kV
ESD per IEC 61000-4-2 (Contact)		±20	
Operating Temperature Range	T _J	-55 to +125	°C
Storage Temperature Range	T _{stg}	-55 to +150	°C

Electrical Characteristics ($T_A=25^\circ\text{C}$ unless otherwise specified)

DUL3311D3L (Marking Code: 33C)						
Parameter	Symbol	Min	Typ	Max	Unit	Test Condition
Reverse Working Voltage	V _{RWM}			3.3	V	
Breakdown Voltage	V _{BR}	4		6	V	I _T = 1mA
Reverse Leakage Current	I _R		1	100	nA	V _{RWM} = 3.3V
Forward Voltage	V _F		0.8	1.2	V	I _F = 10mA
Clamping Voltage	V _C			10	V	I _{PP} = 1A (8 x 20µs pulse)
Clamping Voltage	V _C			20	V	I _{PP} = 5A (8 x 20µs pulse)
Peak Pulse Current	I _{PP}			5	A	t _p = 8/20µs
Junction Capacitance	C _J			0.5	pF	V _R = 0V, f = 1MHz

DUL0511D3L (Marking Code: 35C)

Parameter	Symbol	Min	Typ	Max	Unit	Test Condition
Reverse Working Voltage	V_{RWM}			5	V	
Breakdown Voltage	V_{BR}	6		8	V	$I_T = 1\text{mA}$
Reverse Leakage Current	I_R		1	100	nA	$V_{RWM} = 5\text{V}$
Forward Voltage	V_F		0.8	1.2	V	$I_F = 10\text{mA}$
Clamping Voltage	V_C			15	V	$I_{PP} = 1\text{A}$ (8 x 20 μs pulse)
Clamping Voltage	V_C			26	V	$I_{PP} = 5\text{A}$ (8 x 20 μs pulse)
Peak Pulse Current	I_{PP}			5	A	$t_p = 8/20\mu\text{s}$
Junction Capacitance	C_J			0.5	pF	$V_R = 0\text{V}$, $f = 1\text{MHz}$

Typical Performance Characteristics (TA=25°C unless otherwise Specified)

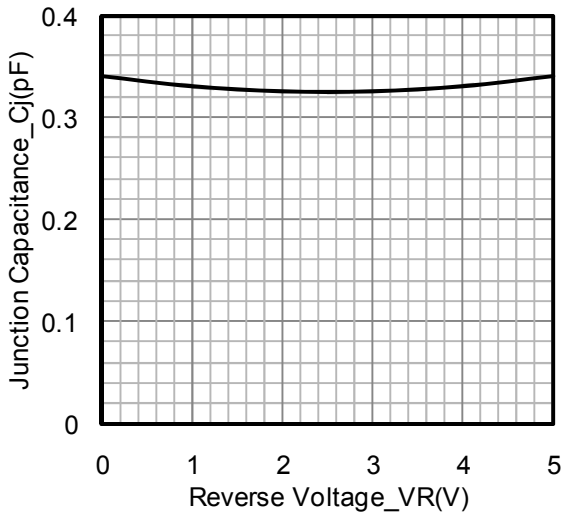

Junction Capacitance vs. Reverse Voltage

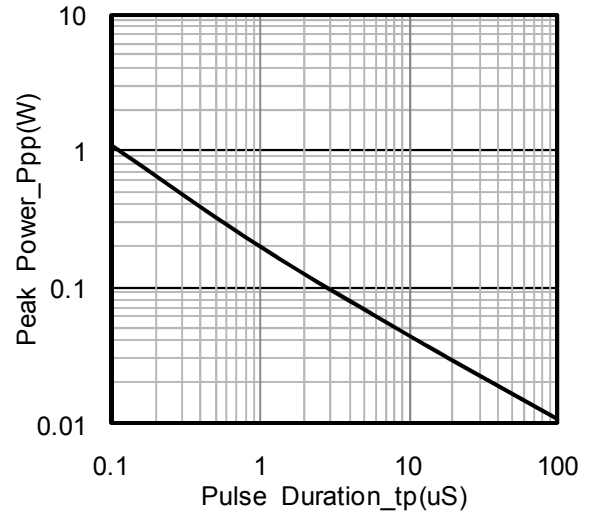

Peak Pulse Power vs. Pulse Time

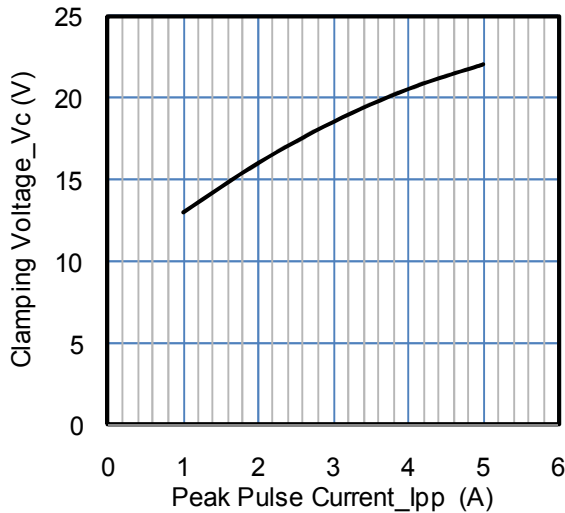

Clamping Voltage vs. Peak Pulse Current

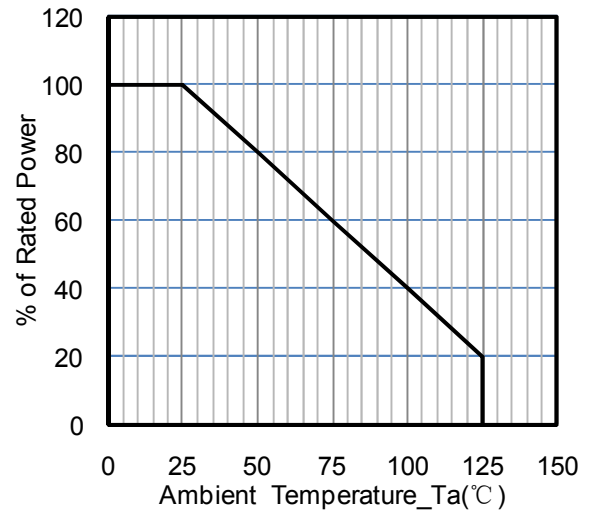

Power Derating Curve

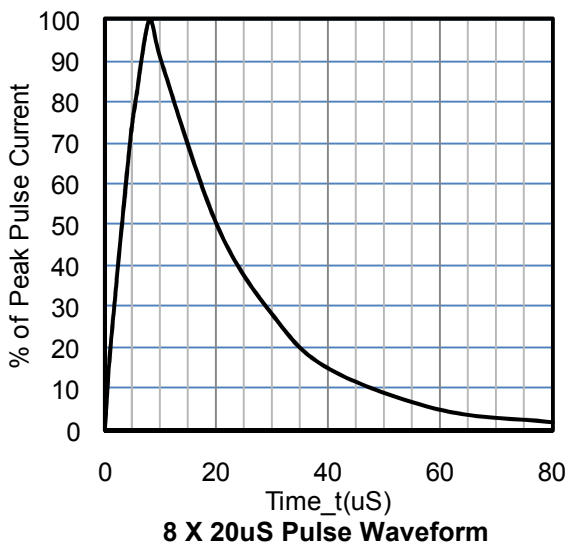

8 X 20uS Pulse Waveform

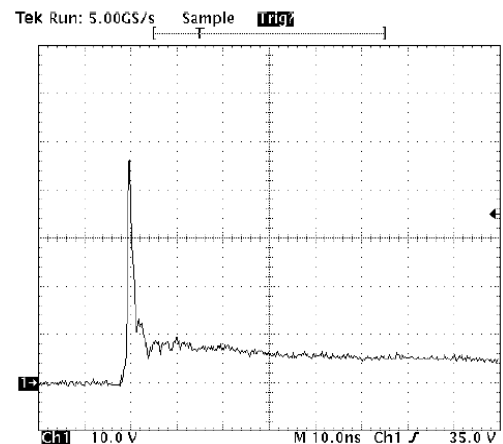

ESD Clamping Voltage

8 kV Contact per IEC61000-4-2

SOD-323 Package Outline Drawing

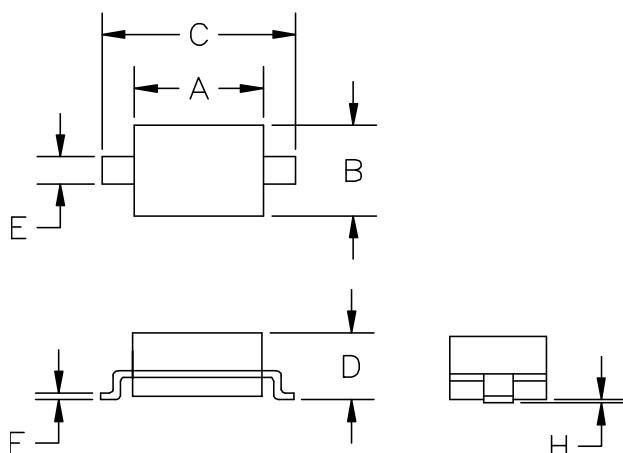

SYM	DIMENSIONS			
	MILLIMETERS		INCHES	
	MIN	MAX	MIN	MAX
A	1.50	1.80	0.060	0.071
B	1.20	1.40	0.045	0.054
C	2.30	2.70	0.090	0.107
D	-	1.10	-	0.043
E	0.30	0.40	0.012	0.016
F	0.10	0.25	0.004	0.010
H	-	0.10	-	0.004

Suggested Land Pattern

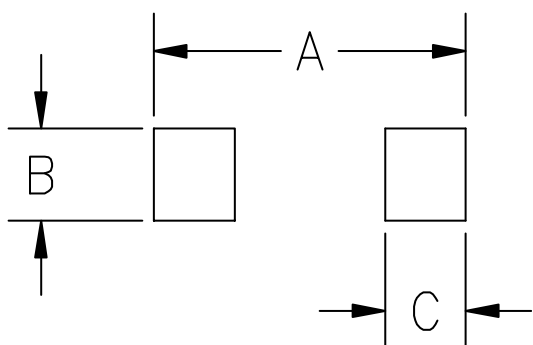

SYM	DIMENSIONS	
	MILLIMETERS	INCHES
A	3.15	0.120
B	0.80	0.031
C	0.80	0.031

Contact Information

Changzhou D-first Electronics CO.,Ltd.

www.first-electronic.com

Email: xhf@first-electronic.cn

Phone: +86 (0519) 8817 1671